

myTeam Sharer

P/N: MTS-100SY

myTeam Sharer/miniDongle

P/N: MTS-101DG

*myTeam Sharer/Dongle

P/N: MTS-102DG (*Optional)

Guía Inicio Rápido



¿Qué hay en la caja?

1x myTeam Sharer

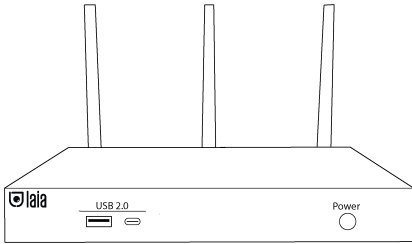

3x Antenas

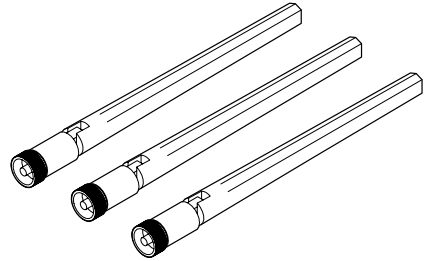

1x USB A/C:myTeam Sharer/miniDongle
P/N: MTS-101DG



1x USB C:myTeam Sharer/Dongle
P/N: MTS-102DG (Opcional)

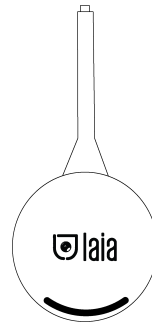

1X Guía rápida
1X Conector RS-232
2X Soportes de fijación
4x Tornillos de fijación



1x Adaptador alimentación

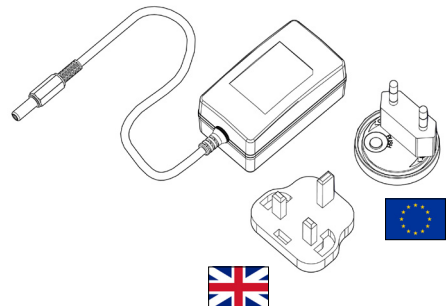

Configuración

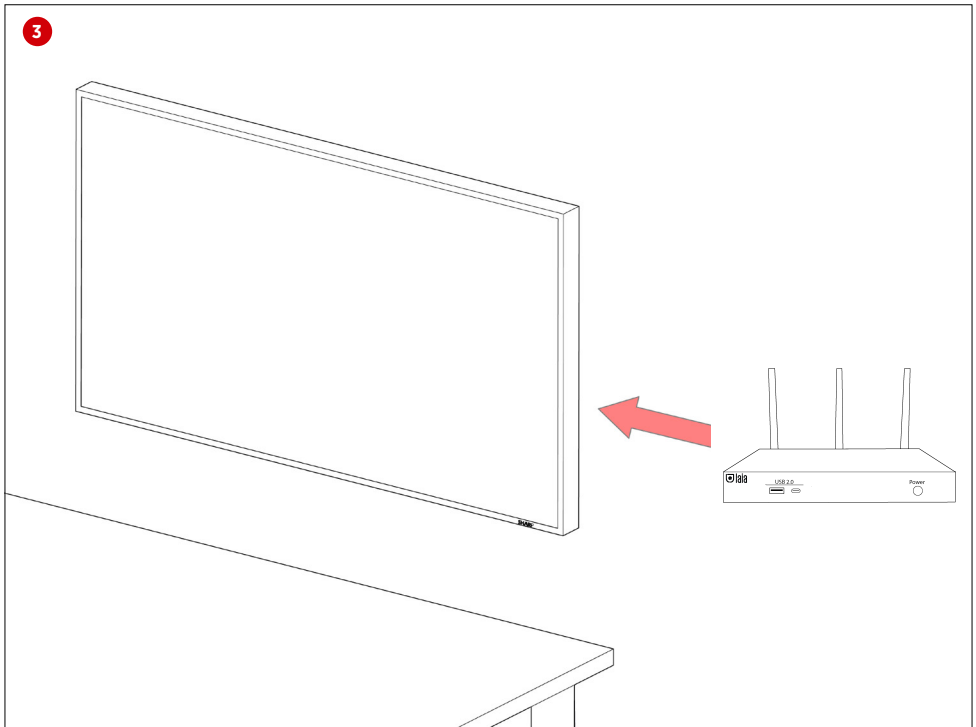
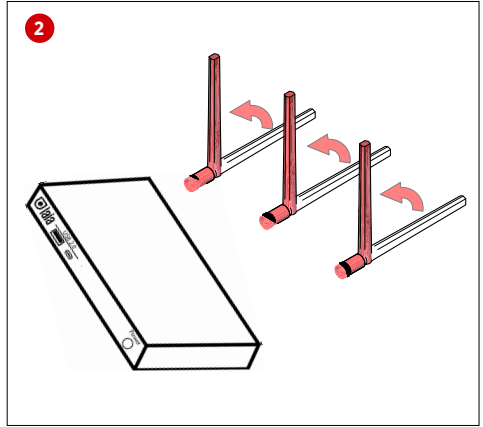
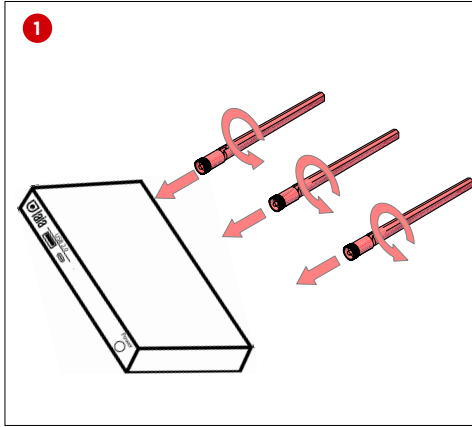

¿Cómo conectar dispositivos externos?

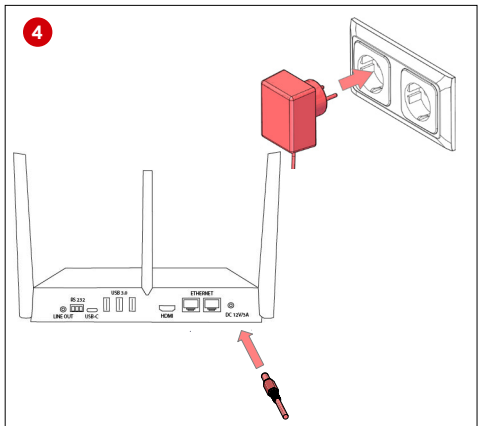
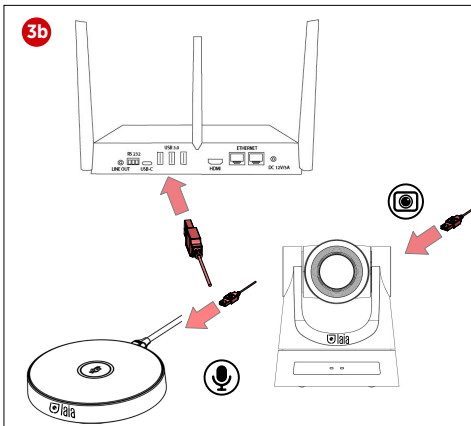
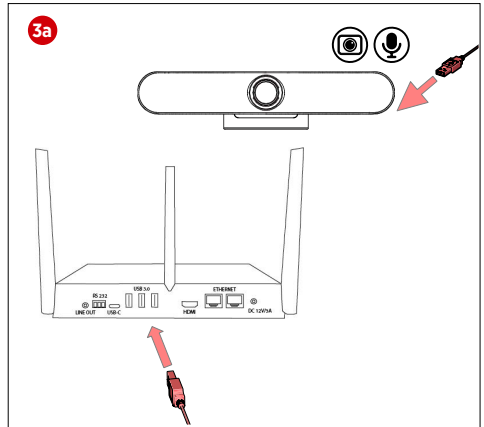
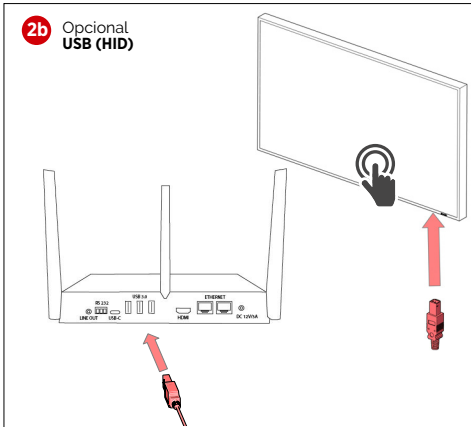
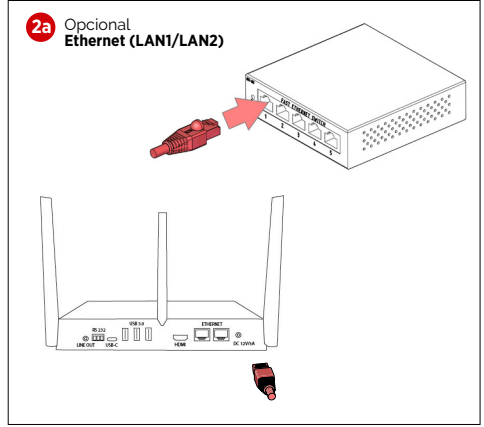
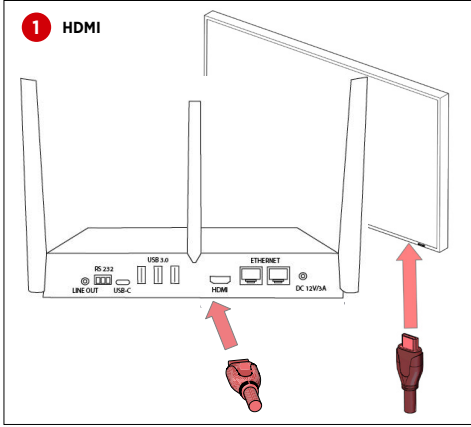

¿Cómo usar myTeam Sharer/Dongle & miniDongle?

*En página 8 podrá ver como realizar conferencia y compartición de pantalla con dongle

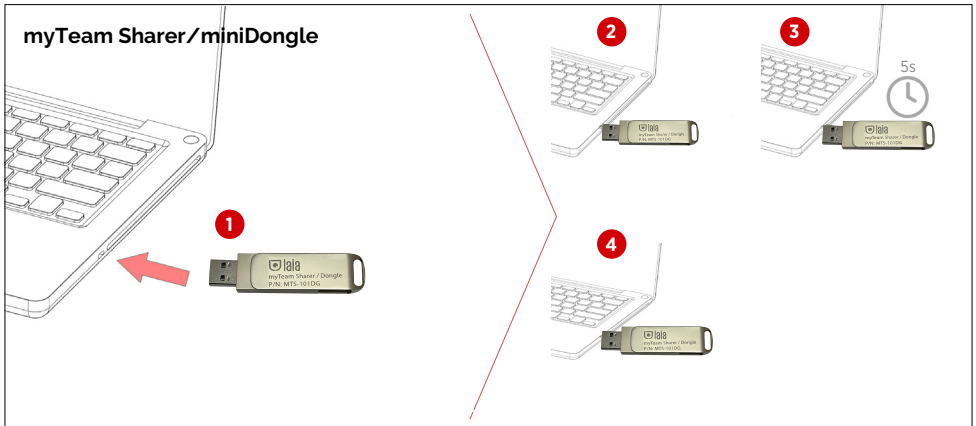
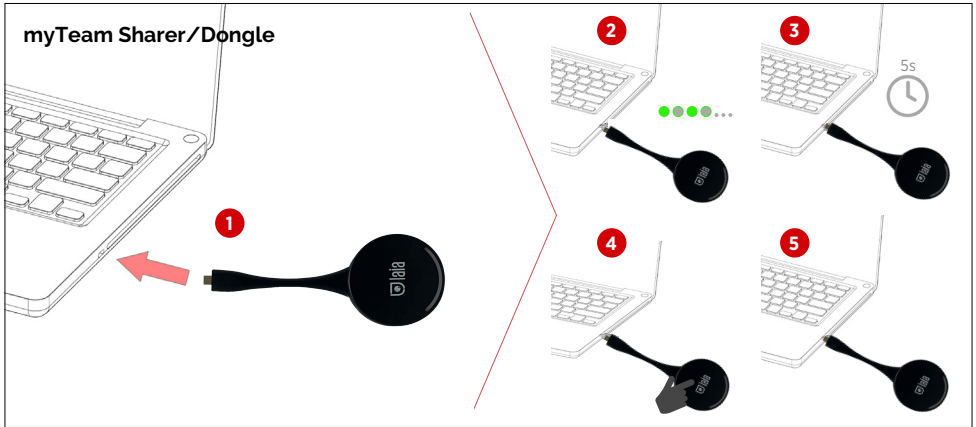

Usa AirPlay, Miracast o Chromecast para compartición de pantalla desde dispositivos móviles.



¿Cómo usar la aplicación Sharer?

Descarga la aplicación conectando una memoria USB al dispositivo

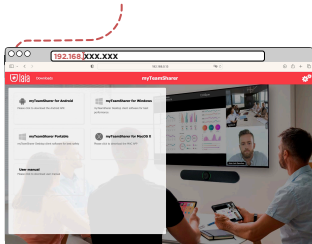

Escriba la IP automática de la pantalla en su navegador

Conecte el dispositivo

Ejecute el programa según su sistema operativo

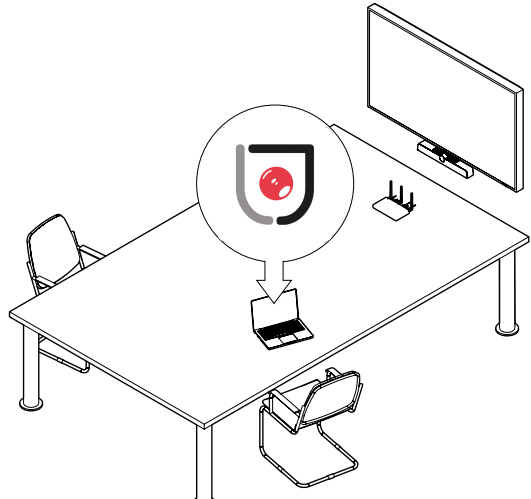

Selecciona MTS-100SY

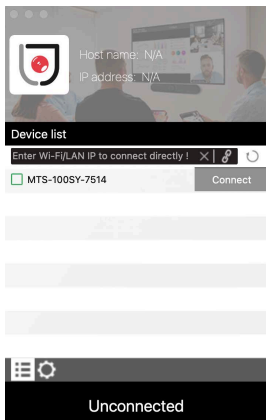

Pantalla completa

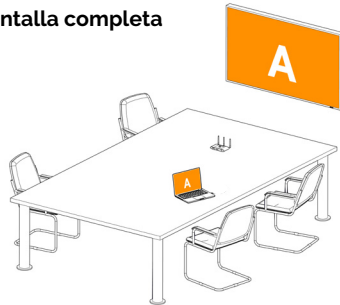

Pantalla compartida

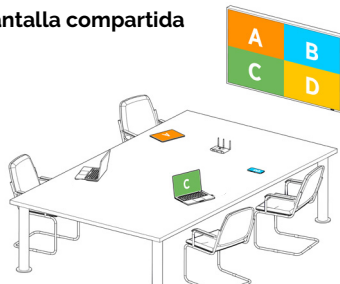

¿Cómo configurar dispositivos externos

Transceptor: Conecte el dongle a su ordenador y ejecute el programa

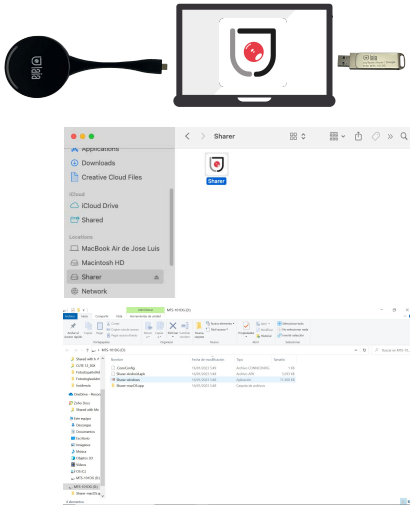

Descargue la app Sharer desde la web

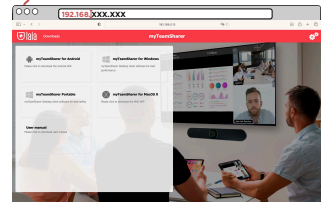

Escriba la dirección IP automática de la pantalla y descargue la app según su S.O.

Configure sus preferencias y dispositivos, seleccionando la pestaña ajustes.

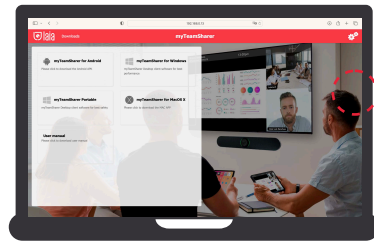

Seleccione el dispositivo preferido para realizar la videoconferencia

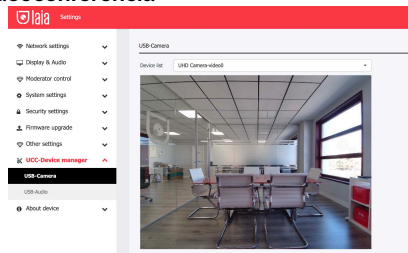
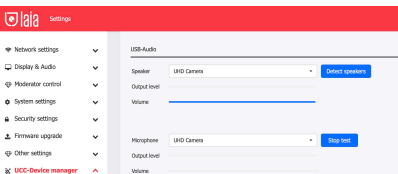

En su aplicación de videoconferencia, seleccione para video "Virtual Meeting Camera" y para audio "Virtual Meeting Audio"

¿Cómo utilizar myTeamSharer/ Dongle?

- **Compartir pantalla**



Conecte el transceptor y el dispositivo estará listo para compartir pantalla



- **Realiza una videoconferencia**



Conecte el transceptor y ejecute Sharer-app

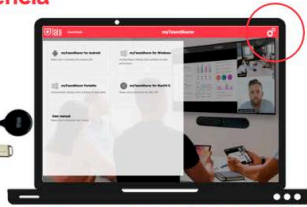

Acceda a configuración desde la IP generada y seleccione ajustes

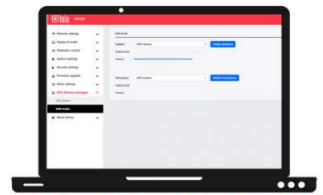

Configure y seleccione los dispositivos que desea utilizar

¿Cómo conectar via software?

- **Compartir pantalla y videoconferencia**

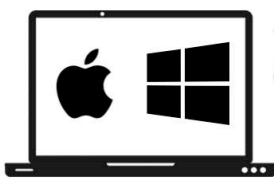

Conecte el dispositivo a la red wifi



- **Realiza una videoconferencia**



Ejecute Sharer-app

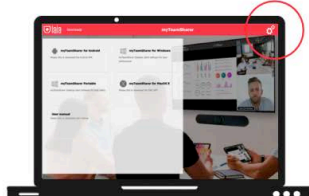

Instale los drivers de audio y video

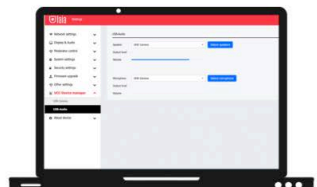

Configure y seleccione los dispositivos que desea utilizar

¿Cómo conectar via **smartphone o tablet?**

- **Compartir pantalla**



Conecte el dispositivo a la red wifi



- **Descargue la aplicación**



Disponible en
Google Play Store



Utilice AirPlay en dispositivos IOS



Compatible con otros métodos de
compartición como Miracast o
Chromecast